

Shower Filter Systems

Compact

Chrome

Brushed Nickel

Handhelds



ProOne®

WATER FILTERS



Instructions

Customer Support:
+1 (800) 544-3533 or
support@prooneusa.com

Thank You...

For purchasing a ProOne® Shower Filter System, featuring improved multi-stage, micro-pore ProMax™ filter technology. Each stage of filtration is comprised of a unique proprietary formula of filtration media designed to target a specific group of contaminants. Like all our filters, the ProMax™ Shower Filter is independently lab tested. It is shown to reduce up to 200 contaminants including VOC's, heavy metals, lead, pesticides, chloramines, chlorine, fluoride, herbicides, pharmaceuticals, and odor. The ProMax™ Shower Filter helps protect your skin and hair from unhealthy effects of contaminants that may be in your water.

Features & Specifications

The new ProMax™ Compact is our latest "all-in-one" shower filter and includes a 3 function swivel shower head. All other styles come with a 5 function swivel massage showerhead. Made from BPA free ABS plastic. Best operated at 80 psi and up to 100°F. Fits 1/2" NPT, ISP, and BSPT thread standards. Flow rated at 2.0 gpm. Includes Teflon sealing tape, Shower arm and flange not included. Standard system comes in chrome, brushed nickel and antique bronze finish. Handheld system comes in chrome finish only. New ProMax™ Compact system comes in chrome only.

Before Installing

1. Unpack ProOne® Shower System assembly. ProOne® Shower Systems come with the ProMax™ filter cartridge and showerhead already installed. It is common to see some black carbon residual media around the filter upon unpacking.
2. Remove existing showerhead from shower arm(pipe) by unscrewing counter clockwise. Do NOT unscrew the shower arm.
3. Clean threaded end of existing shower arm and apply about three layers of the included Teflon tape clockwise(a).
4. Follow installation instructions for appropriate style shower filter.

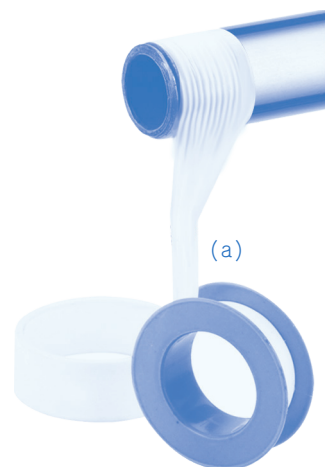

Installation

Insert washer into female threaded end(b) of shower filter housing (end that attaches to shower arm).

Install the shower system assembly onto the shower arm by turning clockwise. Hand tighten only.

Do NOT over tighten as cross threading may occur.

Standard and Compact Shower Systems

1. Turn on water to the desired temperature and rotate shower head to the desired position.
2. Allow water to run for several minutes to activate filter.
3. Enjoy your new ProOne® Shower Filter System with ProMax™ Technology.
NOTE: See **Usage** for adjusting showerhead flow pattern,

Handheld Shower System

1. Handheld Showerhead easily removes from bracket by lifting handle.
2. To adjust handheld position, loosen adjuster nut(c) by turning counter clockwise. Position as desired. Hand tighten adjuster nut clockwise until snug.
3. Turn on water to the desired temperature and rotate shower head to the desired position.
4. Enjoy your new ProOne® Shower Filter System with ProMax™ Technology.
NOTE: See **Usage** for adjusting showerhead flow pattern.

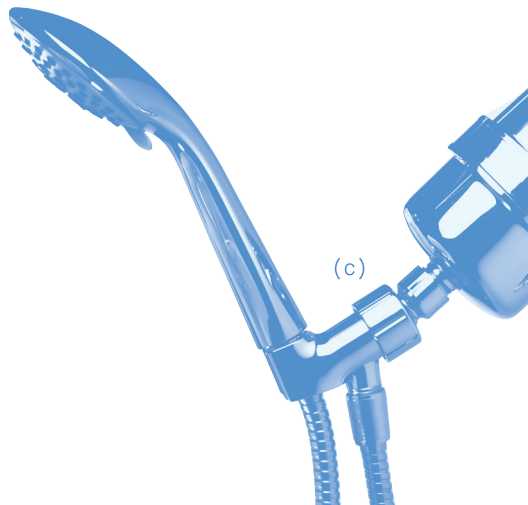
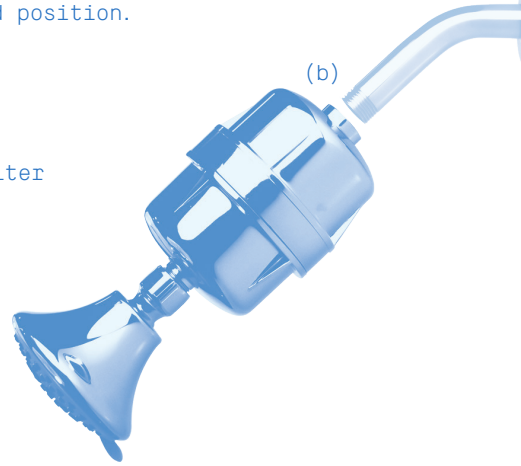

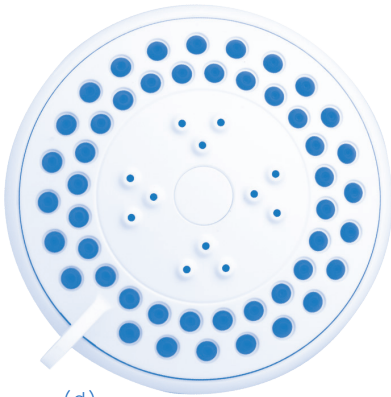

(d)

Usage

The new ProMax™ Compact is our latest “all-in-one” shower filter and includes a 3 function adjustable flow swivel massage shower head. All other styles come with a 5 function adjustable flow swivel massage showerhead. Move slider tab (d) to adjust flow pattern.

ProMax™ Filter Cartridge Replacement

1. Unscrew the shower filter assembly from the shower arm by turning counter clockwise.
2. Unscrew the filter housing by placing one hand on top and the bottom portion of the filter housing as shown in image(e).
3. Remove the cartridge. Make sure O-rings inside of filter housing remain seated in O-ring grooves. Top of housing(f) fits (2) O-rings. Bottom of housing(g) fits (1) O-ring.
4. Replace with new cartridge.
NOTE: Screen mesh end must be facing up towards shower arm.
5. Screw housing back together.
6. Replace Teflon tape on shower arm. Reattach housing onto shower arm by turning clockwise.
NOTE: Filter cartridge is NOT reversible

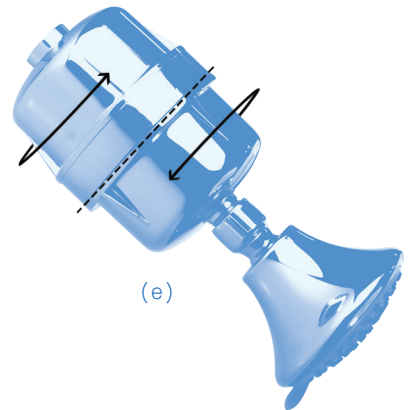

(e)

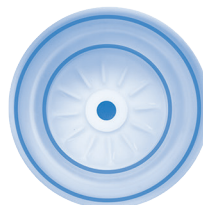
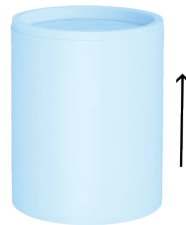

(f)

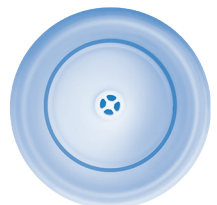

(g)

- * Recommended filter replacement is every 6-9 months.
Replacement filter: PM-RF

ProMax™ Compact Shower System

1. Unscrew the shower filter assembly from the shower arm by turning counter clockwise.
2. Unscrew the filter housing by placing one hand on top and the bottom portion of the filter housing as shown in image(h).
3. Remove the cartridge. Make sure O-rings inside of filter housing remain seated in O-ring grooves. Top of housing(f) fits (2) O-rings. Bottom of housing(g) fits (1) O-ring.
4. Replace with new cartridge.
NOTE: Screen mesh end must be facing up towards shower arm.
5. Screw housing back together.
6. Replace Teflon tape on shower arm. Reattach housing onto shower arm by turning clockwise.
NOTE: Filter cartridge is NOT reversible

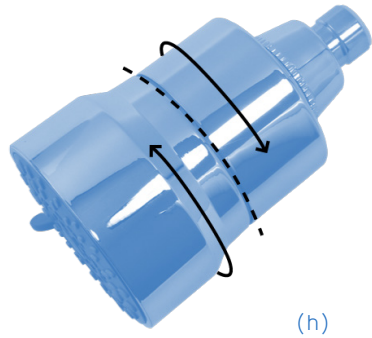

(h)

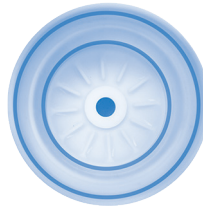

(f)

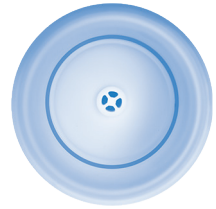

(g)

- * Recommended filter replacement is every 3-4 months.
Replacement filter options:
PM-8000-FRF (fluoride filter)
PM-8000-LRF (lead filter)

Troubleshooting

If there is leakage between the two housings, try tightening both housings. Check the O-rings to make sure they are seated in their proper grooves. The O-rings may need to be lubricated with food grade silicone lubricant. When reinserting o-rings, turn o-ring upside down before inserting into corresponding groove.

ProOne®

WATER FILTERS



**Most tested.
Most trusted.**

ProOne® LIMITED WARRANTY:

Lincoln-Remi Group, LLC d/b/a ProOne® Water Filters("PO") sells its products with the intent that they are free from defects in materials and workmanship under normal use and care. PO provides a limited warranty to the original retail purchaser of ProOne® products ("Customer") of those ProOne® products described in this Limited Warranty when purchased from ProOne® or an authorized ProOne® dealer. PO will repair or replace any ProOne® product, at its sole discretion during the warranty period under the specific conditions found on the last page of the product Installation Manual:

1. Product Name: Shower Filter Systems

2. If during the one (1) year following the purchase of a ProOne® Shower filter system and 6 months for the shower filter cartridge excluding the filter media, PO will replace or repair any component in these systems when found to be defective by ProOne®,

2. No warranty is given as to the service life or performance of any filter media or any filter element because performance of ProOne® filters will vary with water conditions and water consumption. Customer is encouraged to visit the Lab Report Disclaimer under Terms and Conditions at www.prooneusa.com.

3. Any damage caused by misuse or abuse; accident; improper installation; dropped product; failure to follow recommended installation or provide recommended maintenance; transportation damage; neglect; environmental conditions; or any other conditions whatsoever that are beyond the control of PO are excluded from this warranty. ProOne® Shower filter systems are NOT intended to be used as a grab device for any purpose. Use of other than the provided shower filter head will VOID this warranty.

4. This express limited warranty is the sole and exclusive warranty.

5. ALL OTHER WARRANTIES, WHETHER EXPRESS OR IMPLIED, INCLUDING BUT NOT LIMITED TO, ANY IMPLIED WARRANTIES OF MERCHANTABILITY, FITNESS OR FITNESS FOR ANY PARTICULAR PURPOSE OR ANY OTHER POTENTIAL OBLIGATION ON THE PART OF PO WITH RESPECT TO PRODUCTS SOLD BY PO ARE DISCLAIMED. EXCEPT FOR ANY EXPRESS WARRANTIES, ALL ProOne® PRODUCTS ARE SOLD "AS-IS". PO shall not be held liable for any incidental, consequential or special damages of any sort whatsoever. The liability of PO is limited to the original retail purchaser and to the repair or replacement of defective components only during the Warranty Period. Labor charges incurred are not covered under this warranty. No refunds will be given at any time to anyone other than the original retail purchaser, except as provided in the refund policy of ProOne®. Please visit Refunds and Returns under Terms and Conditions at www.prooneusa.com. The Customer is also encouraged to review the Lab Report Disclaimer under Terms and Conditions at www.prooneusa.com. The liability of PO terminates upon the expiration of the Warranty Period or transfer of product ownership.

6. To obtain warranty service on, or replacement of a ProOne® product, Customer should contact ProOne® customer service by email to support@prooneusa.com to confirm eligibility of warranty. Customer may be asked to send, at the sole expense of the Customer: (a) the product including its original packaging; and (b) the dated sales receipt as proof of purchase, and a prepaid return package, to the following address: ProOne, 1200 Benstein Rd, Commerce Twp., MI 48390, NO C.O.D.'s will be accepted.

7. This warranty provides you with specific legal rights. You may have additional rights which may vary from country to country. Because of individual country laws and regulations, some of the above limitations and exclusions may not apply to you. For any warranty questions, please call [1-800-544-3533](tel:1-800-544-3533) or email to support@prooneusa.com.

Attention CA, IA and WI Consumers. In compliance with states' law, ProOne products are sold and shipped to residents of these states without any health-related performance claims except for aesthetics including chlorine reduction and improvement with taste, odor and sediment. Other states may apply.